

MONTAGEKONSOLEN/MOUNTING BRACKETS **XLINE XLE/XLD**

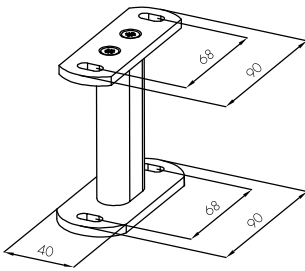

Distanzkonsole XL
distance bracket XL

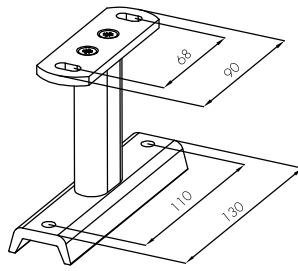

Distanzkonsole U-XL
distance bracket U-XL

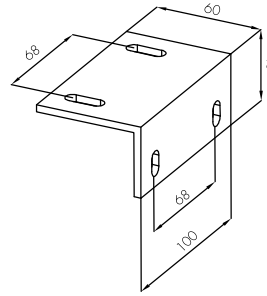

Laibungswinkel XL
support for reveal mounting

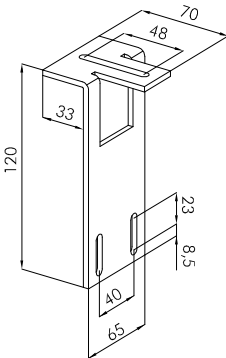

Winkel für Stegmontage DFS
support for bar assembly DFS

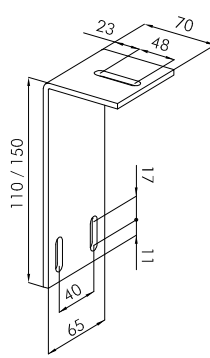

Winkel für Stegmontage SFS
support for bar assembly SFS

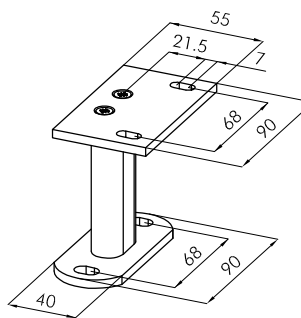

Halter Führungsschiene XL einseitig
Support for single guiding rail

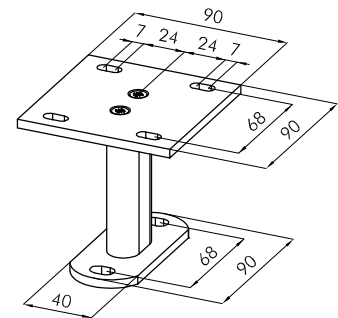

Halter Führungsschiene zweiseitig
Support for double guiding rail

MONTAGEARTEN/MOUNTING VARIATIONS **XLINE XLE/XLD**

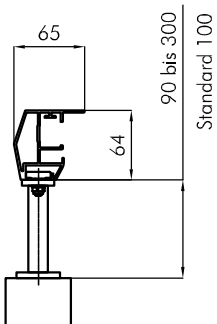

Führungsschiene mit Distanzkonsole
guiding rail with distance bracket

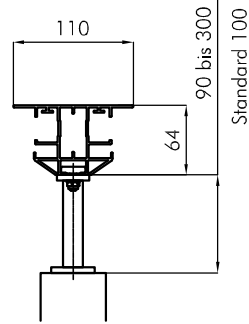

Mittenführungsschiene mit Distanzkonsole
centre guiding rail with distance bracket

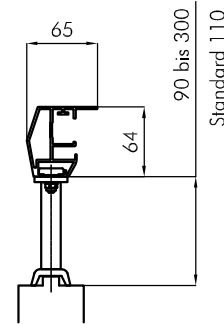

Führungsschiene mit Distanzkonsole U-XL
guiding rail with distance bracket U-XL

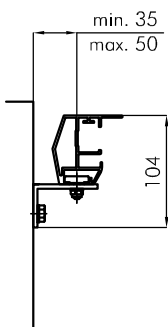

Führungsschiene mit Laibungswinkel
guiding rail with support for reveal mounting

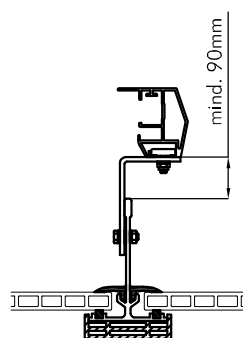

Führungsschiene mit Falzmontage
guiding rail with bar assembly

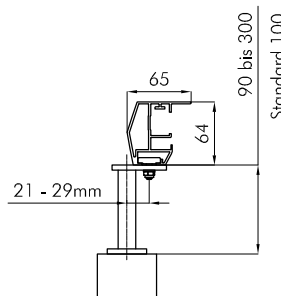

Halter Führungsschiene XL einseitig
Support for single guiding rail

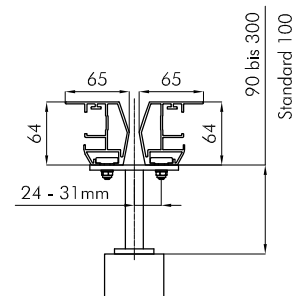

Halter Führungsschiene zweiseitig
Support for double guiding rail

UNTERGLASMONTAGE / MOUNTING UNDERGLASS **XLINE XLE**

